



HBM 400PS L-802A Airport Rotating Beacon



Compliance with Standards:

FAA: L-802A A/C150/5345-12 (Current Edition)
ICAO: Annex 14, para 5.3.3

Applications:

L-802A Rotating Beacons are designed primarily for night operation as identification and location markers for airports.

Features:

- Patented belt-drive system eliminates the lubrication maintenance required by conventional gear-drive beacons (U.S. Pat. 5,339,224)
- Patented liquid-filled lamp connector, eliminating the slip rings and brushes found on conventional beacons (U.S. Pat. 5,816,678)
- Two 40,000 lumen, 400 watt pulse-start metal-halide lamps
- Pulse-start lamps are fully bright in 3-5 minutes
- 26,000 hour typical lamp life (6 years)
- One clear lens, one aviation green lens
- NO maintenance except lamp replacement
- All moving parts are permanently lubricated
- Thermally-protected motor eliminates burnouts
- Lamps preset 5° above horizontal, adjustable
- 12 RPM rotation, 24 flashes/minute
- Weatherproof steel cabinet, powder coated international orange
- Optional stainless steel cabinet & bearings for highly corrosive environments
- Class I temperature range: -30 to +55 °C (-22 to +131 °F)
- Class II temperature range: -55 to +55 °C (-67 to +131 °F)
- Tested to wind velocities of 100 mph
- Optional photocell and/or tell-tale relay
- Mountable on a Hali-Brite Tipdown Pole
- Power Consumption: 965W Class I, 1365W Class II
- Manufactured in the USA







Optional Beacon Tipdown Pole

Sales and Technical Support:

1.800.553.6269

Sales@halibrite.com

 Hali-Brite, Inc.
1119 Madison Street
Brainerd, MN 56401

 www.halibrite.com
 Ph: 218.454.0956
 Fax: 218.454.0972

Ordering Information

Part Number	Description
L802A6116	120 VAC, 60 Hz, Class I
L802A6125	220-240 VAC, 50 Hz, Class I
L802A6126	220-240 VAC, 60 Hz, Class I
L802A6216	120 VAC, 60 Hz, Class II
L802A6225	220-240 VAC, 50 Hz, Class II
L802A6226	220-240 VAC, 60 Hz, Class II

NOTE: 220-240 VAC must be single wire with neutral

Options

Part Number	Description
L801/802 T/T HBM 120	TELL-TALE RELAY, 120 VAC
L801/802 T/T HBM 240	TELL-TALE RELAY, 220-240 VAC
4200-0000A	TOWER MOUNTING KIT
L801/L802 HBM SS	STAINLESS STEEL OPTION

Replacement Parts

Part Number	Description
0200-0021	Ballast Assembly, 60 Hz
0200-0022	Ballast Assembly, 50 Hz
0600-0003	Belt
2300-0003	Lamp Fuse, 10 amp
2300-0002	Motor Fuse, 1/2 amp
3400-0400/H75/PS	Lamp, 400 watt
2800-0035	Lens, Clear
2800-0044	Lens, Green
0100-3825	Lens Clip

Shipping Information

Unpackaged Weight: 150 pounds

USA Shipping Weight: 250 pounds

USA Shipping Volume: 48"x40"x33"

International Shipping Weight: 250 pounds

International Shipping Volume: 48"x40"x33"

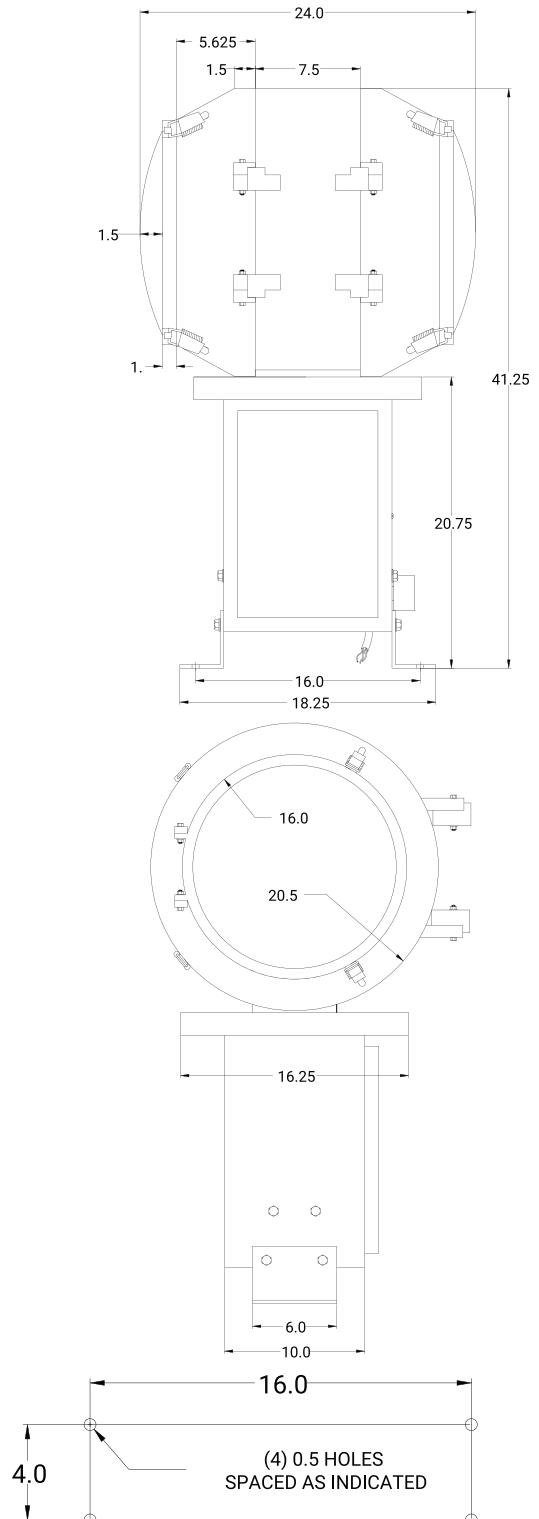



Sales and Technical Support:

1.800.553.6269

Sales@halibrite.com

 Hali-Brite, Inc.
1119 Madison Street
Brainerd, MN 56401

 www.halibrite.com
 Ph: 218.454.0956
 Fax: 218.454.0972